

**build it!**

# Rustic Coffee Table

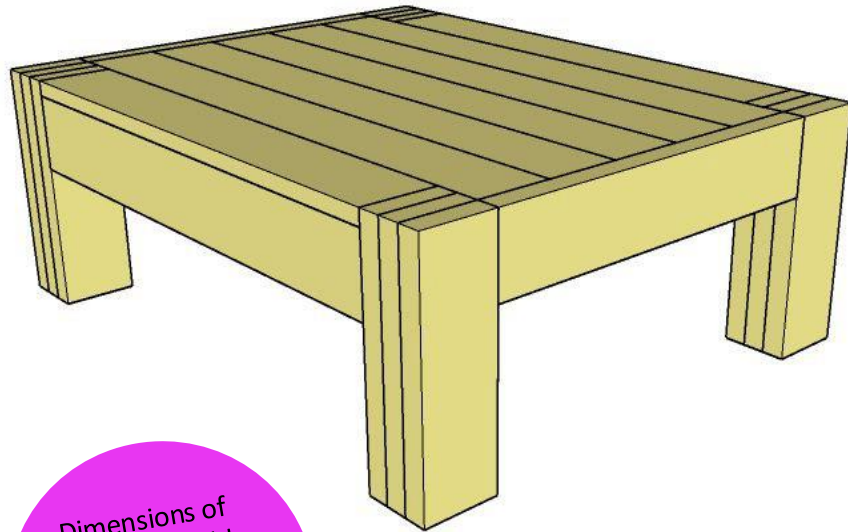

Dimensions of  
completed table  
are:  
 $38\frac{1}{4} \times 43\frac{1}{2} \times 15\frac{3}{4}$

Thank you for purchasing my Rustic Coffee Table building plan! This is a beginner level build so if you don't have a ton of experience, it's totally fine!

This table is made from 2x6s but I did plane them. Wood typically has rounded edges so it's customary when building furniture to plane it first. Planing is a technique when wood is shaved/cut down to create a smooth, even finish. You can do this by using a planer or by trimming the wood down on each side with a table saw.

Please **take safety precautions** when operating tools and always follow the manufacturer's instructions.

Neither the publisher or author shall be liable for any injury or loss of any kind resulting from information gained from this resource.

# LEGAL business

This resource is protected by domestic and international copyright laws. You may print a copy of this for your personal use but no part of this publication may be reproduced, sold, stored, or transmitted in any form by any means, electronic, mechanical, photocopying, recording, scanning, or otherwise without prior permission.

Unauthorized reproduction or distribution is prohibited.

If you have any questions or need permission for something, please reach out to us at [hello@onehandymomma.com](mailto:hello@onehandymomma.com). We're happy to chat!

By downloading and using this resource, you agree to follow the rules laid out in this copyright notice.

Thanks for understanding!

Nneka

# MATERIALS list

---

- 7 - 2x6x96 pieces of wood
- Kreg Jig Pocket Hole screws 2-1/2 inch long
- Wood Glue
- Stainable/Paintable wood filler
- Paint / Stain of your choice
- Clamps *(will be used to clamp table legs together while drying)*

## TOOLS

- Drill
- Kreg Jig Tool
- Rubber Mallet (optional)
- Sander *(I like using an orbital sander but you can use a hand sander as well)*
- Planer or table saw *(optional\* if you want cleaner lines)*

# CUT list

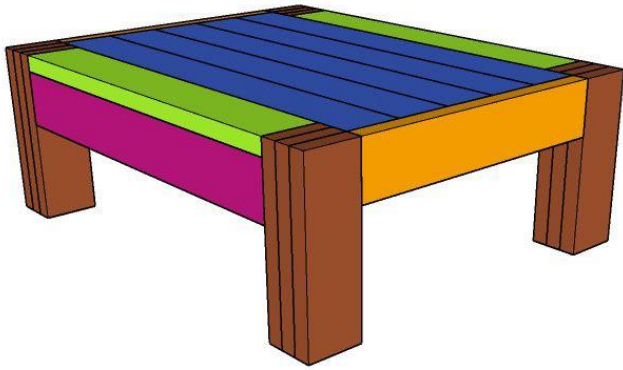

- 5 - 41" long (table top)
- 2 - 35" long (table top)
- 2 - 35" long (front/back aprons)
- 2 - 25" long (side aprons)
- 12 - 15 3/4" long (table legs)

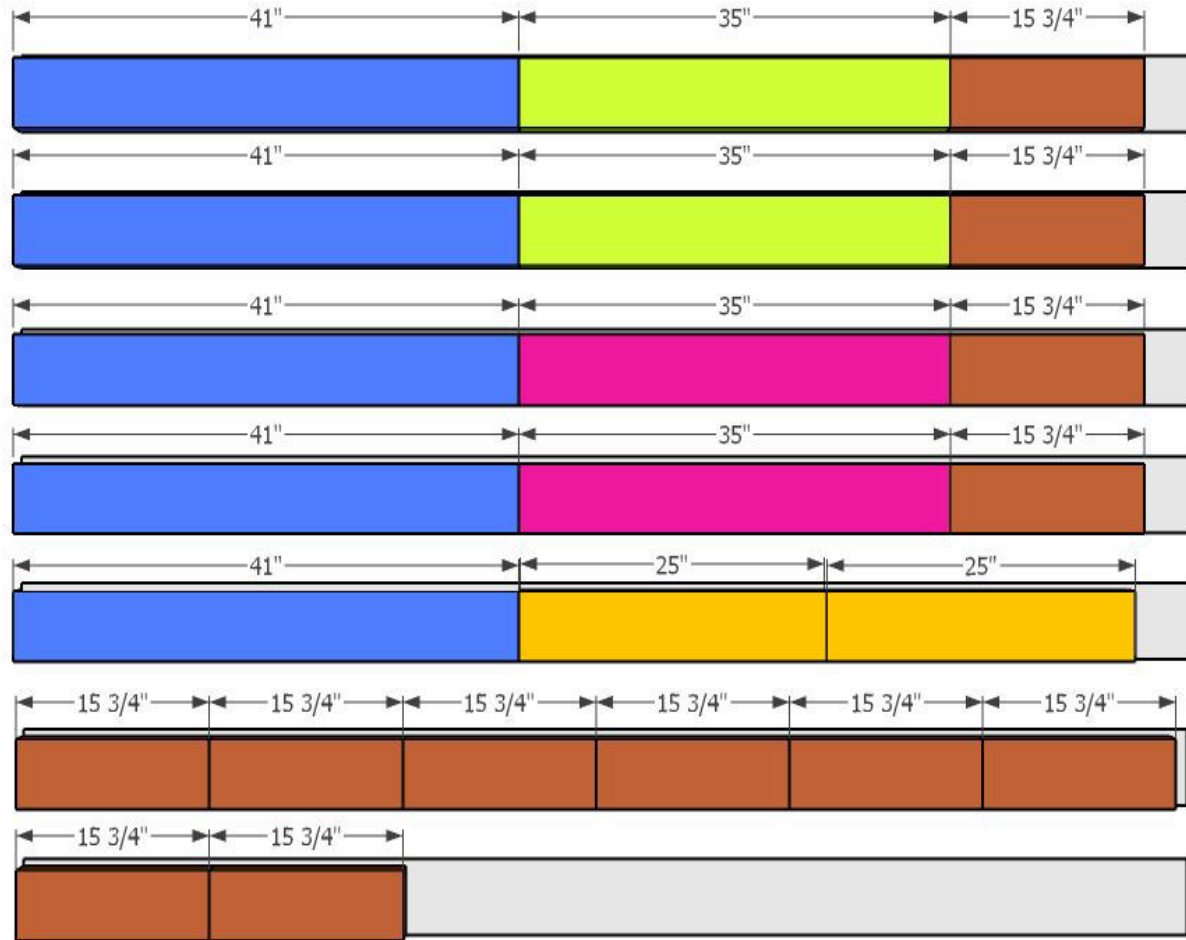

# THE BUILD instructions

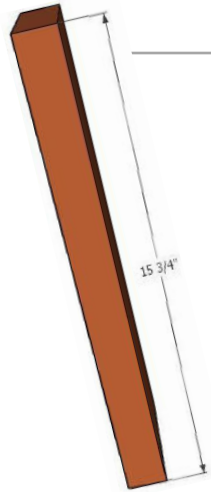

Each leg is made of 3 - 15 3/4" boards laminated together. Spread glue on each mating face and then clamp together, making sure the edges are flush. Allow to dry overnight.

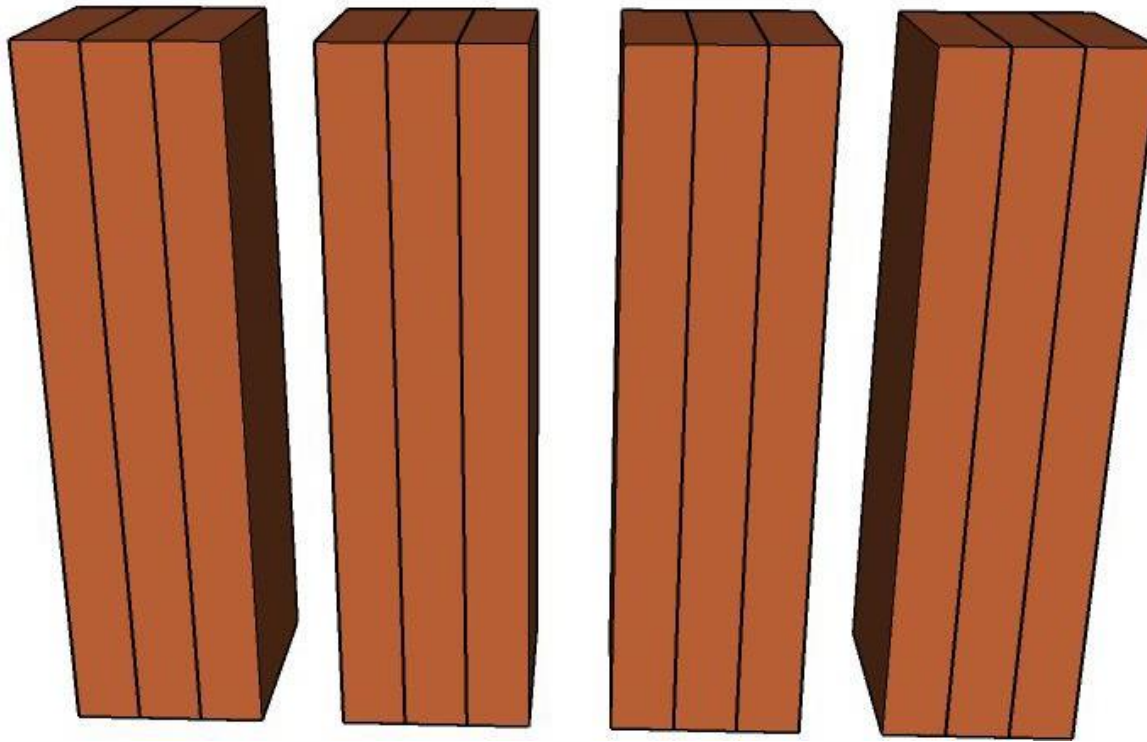

# TABLETOP

The main tabletop is made of **5 - 41"** and **2 - 35"** boards. Drill your pocket holes in each board then spread glue on each edge making sure the edges are flush. Now install the pocket hole screws in boards. You will also add pocket holes at each end as well. We'll use those later.

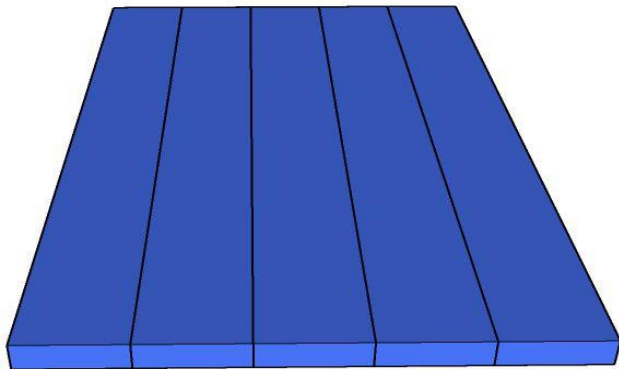
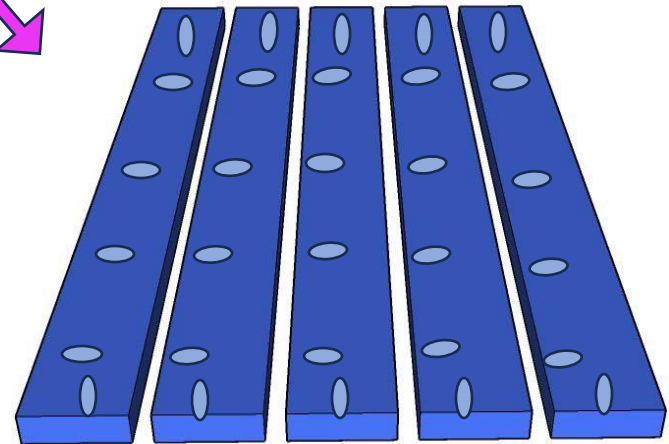
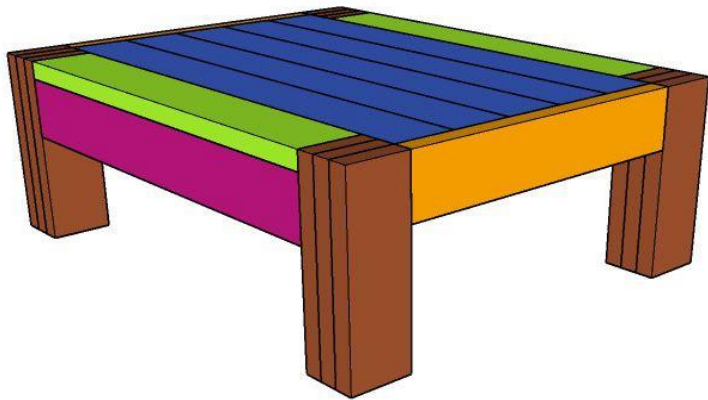

Boards attached together

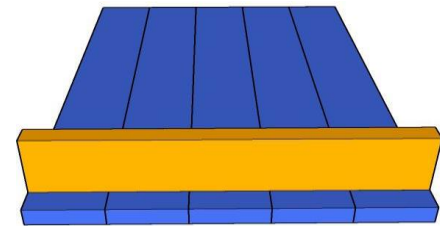

Now is the time to check that the **ACTUAL** measurement of the Main Tabletop matches the short aprons.

# ATTACHING LEGS TO SHORT APRONS

Add 2 pocket holes to each side of the short (25") aprons and attach as pictured using wood glue & screws.

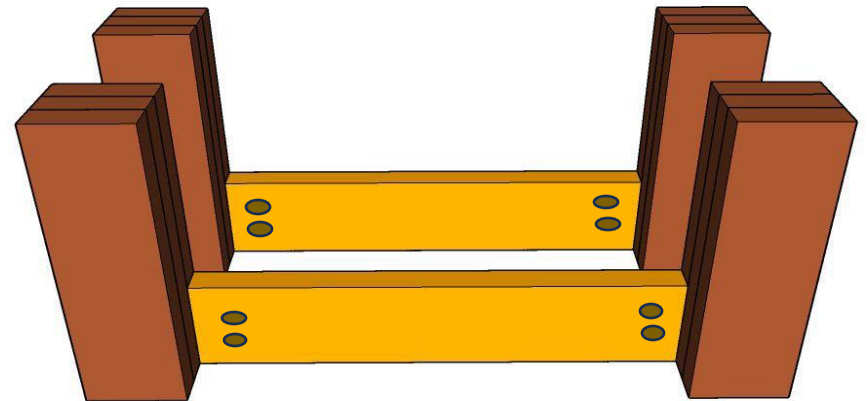
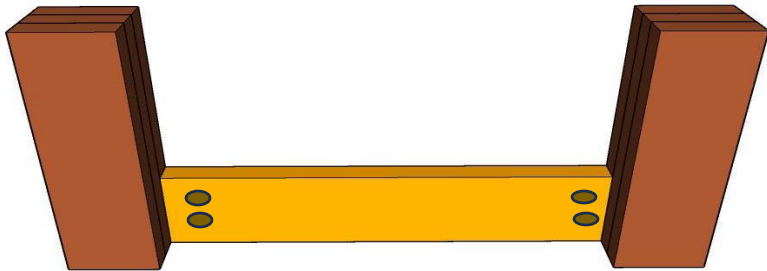
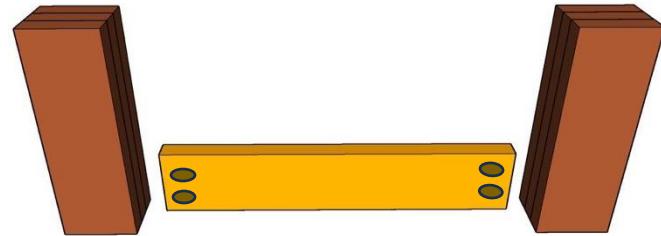
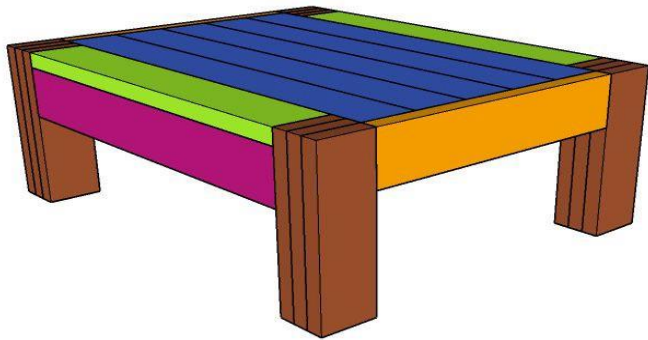

# PREPARE LONG APRONS

---

Add 2 pocket holes to each side of the short (35") aprons and 4 at top then sit aside.



# ATTACHING TABLETOP

---

Glue and screw each Leg Unit to the main tabletop.

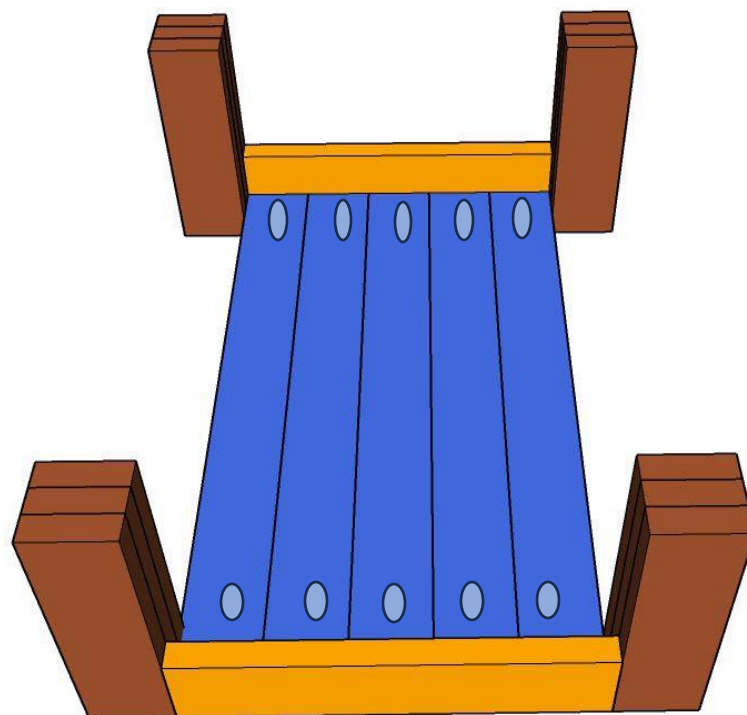
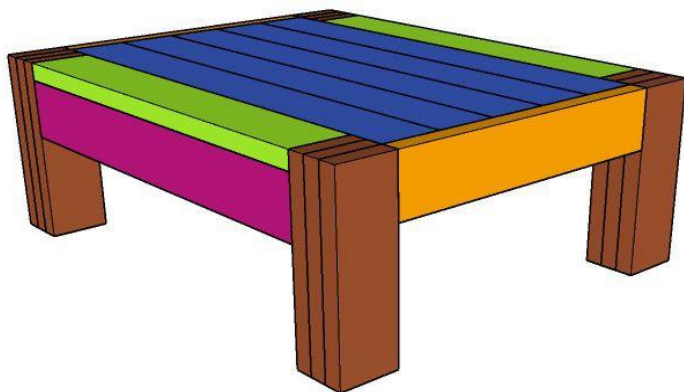

## ATTACHING TABLETOP (cont.)

---

Attach **table top sides (35")** then the **front and back aprons (35")** using glue and screws.

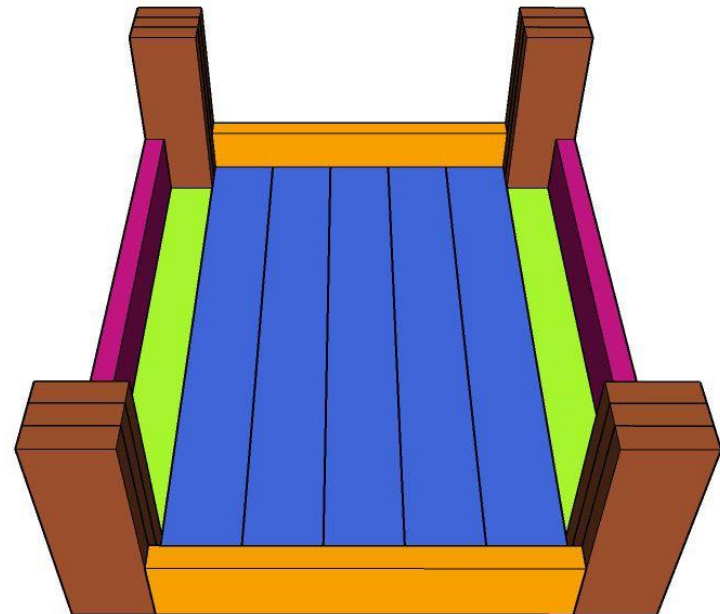
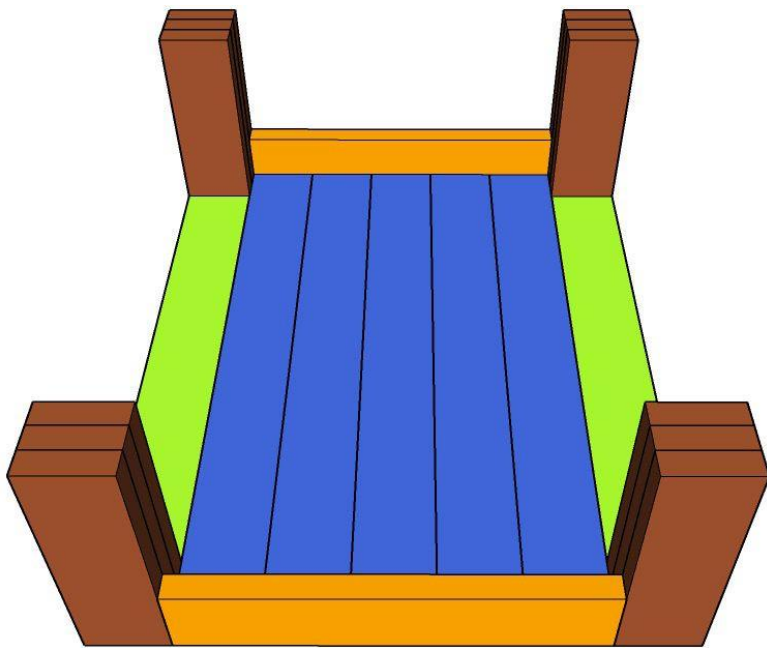

# FINAL STEPS

---

- The table is heavy so you may need help moving it once it's complete.
  - Fill any gaps with wood filler and let dry.
- Sand the entire table using an orbital sander or hand sander.
  - Stain or paint table to your taste.
  - Add a polyurethane top coat.

# All done!

---

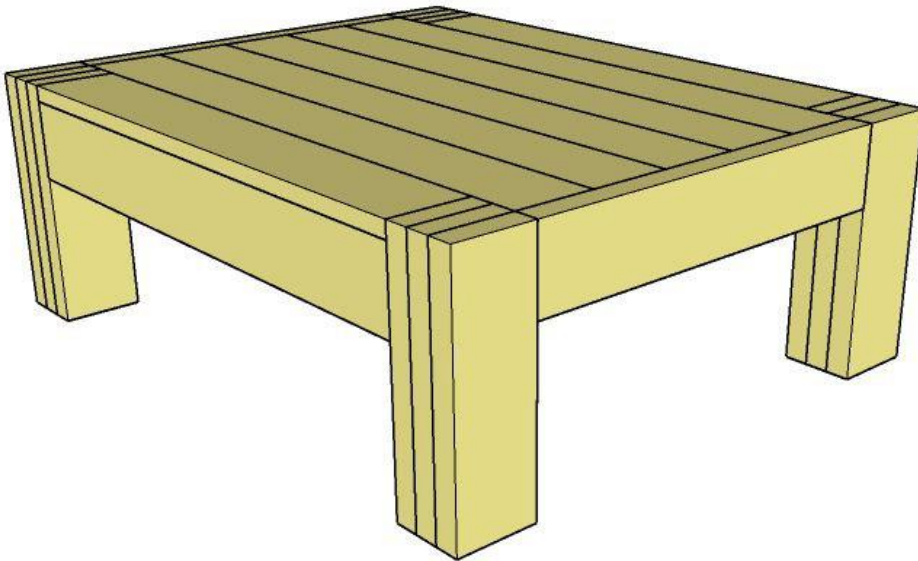

Enjoy your rustic coffee table!

I'd love to see your finished build so  
be sure to tag me on Instagram at  
[@onehandymomma!](https://www.instagram.com/onehandymomma/)